

SENSOR WALL 180°

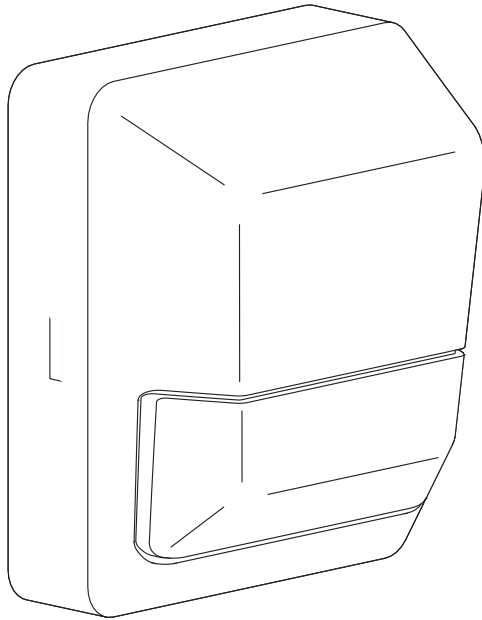

	EAN	IP	IK	Δ (°C)	V~	Hz	▽ (°)
SENSOR WALL 180DEG IP55 WT	4058075244771	55	05	-20...+40	220-240	50/60	180
SENSOR WALL 180DEG IP55 DG	4058075244795	55	05	-20...+40	220-240	50/60	180

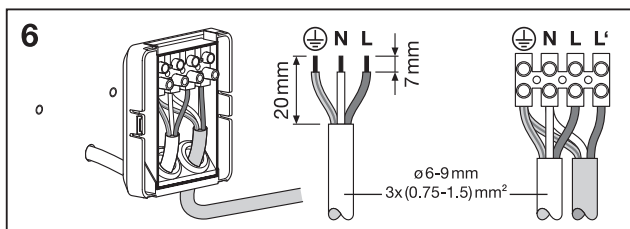

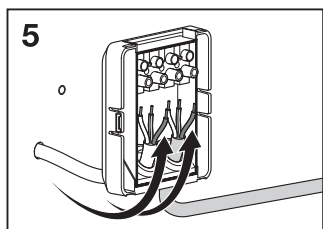
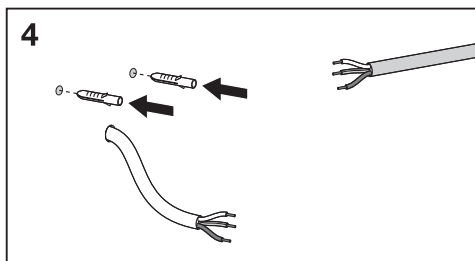
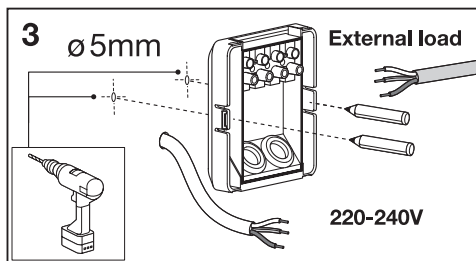
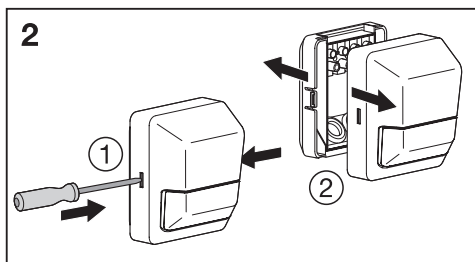
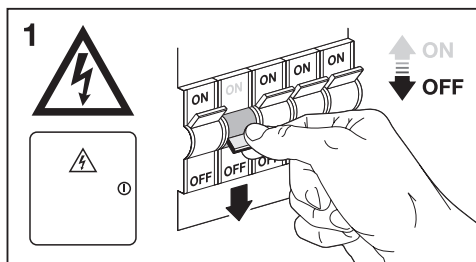
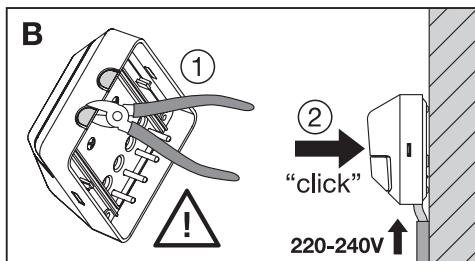
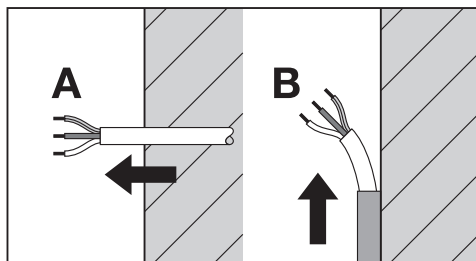
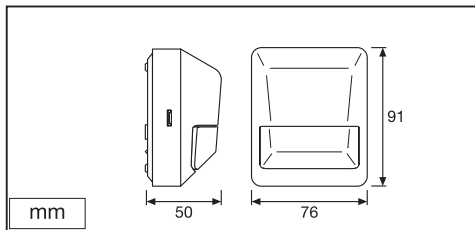
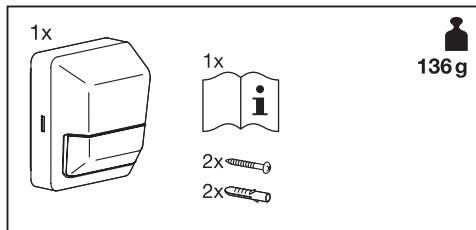
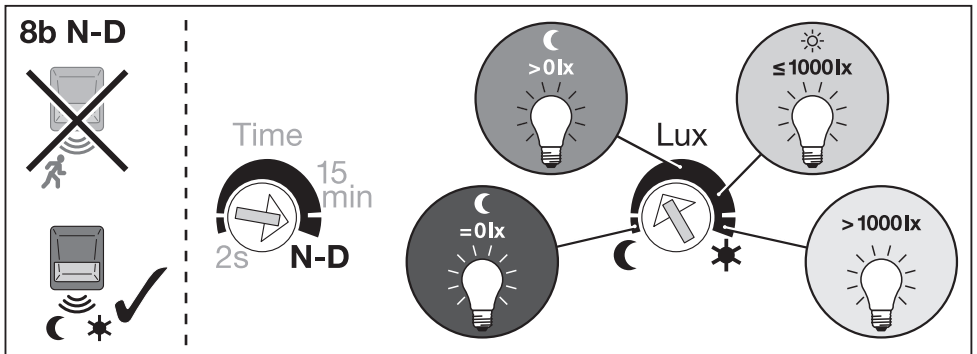
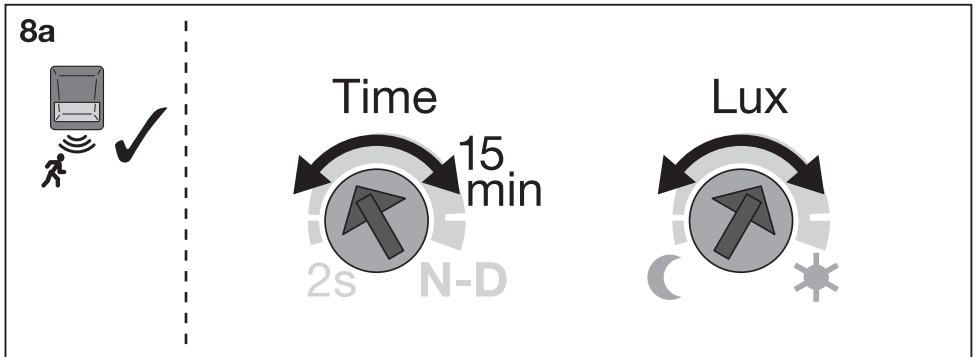
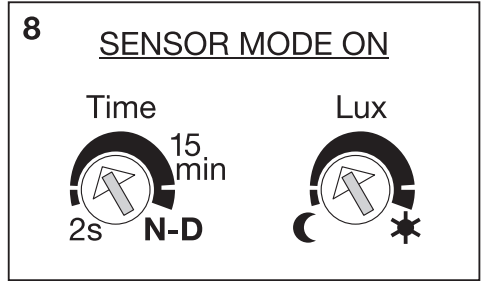
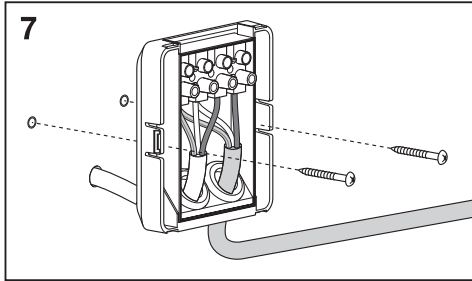
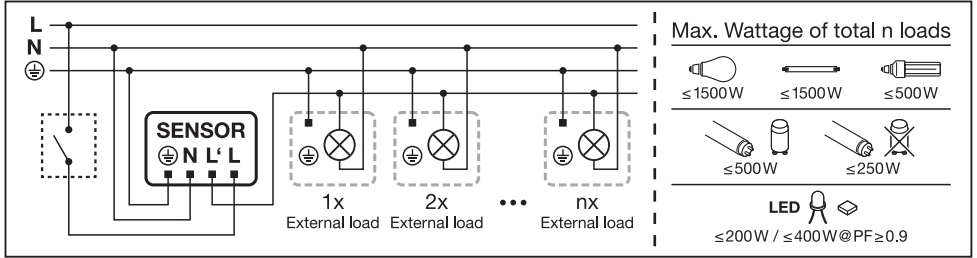
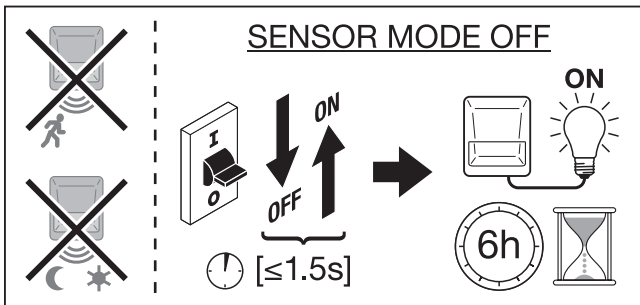
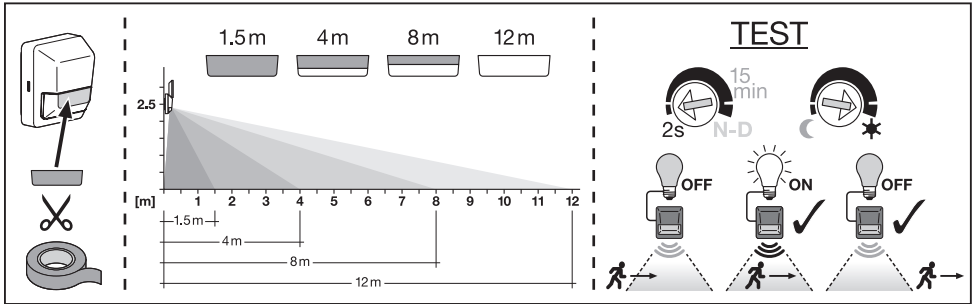
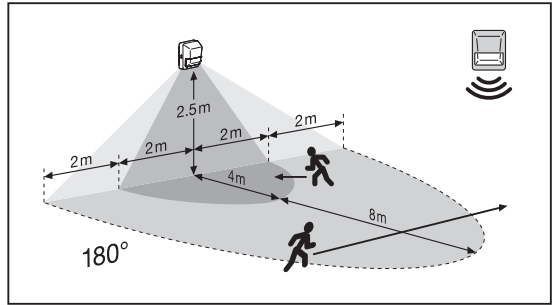
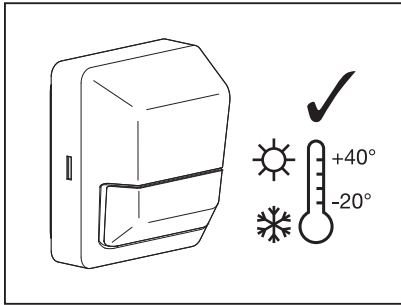
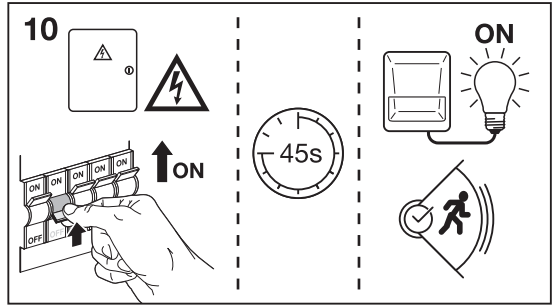
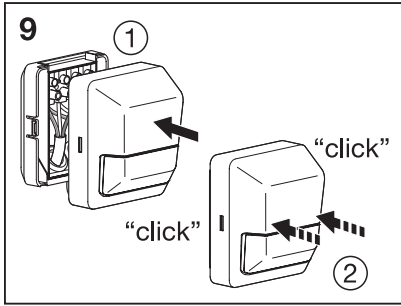



C10449057
G11146482
22.07.2022



LEDVANCE GmbH
Steinerne Furt 62
86167 Augsburg, Germany
www.ledvance.com